

4x3+1,0 VD/T

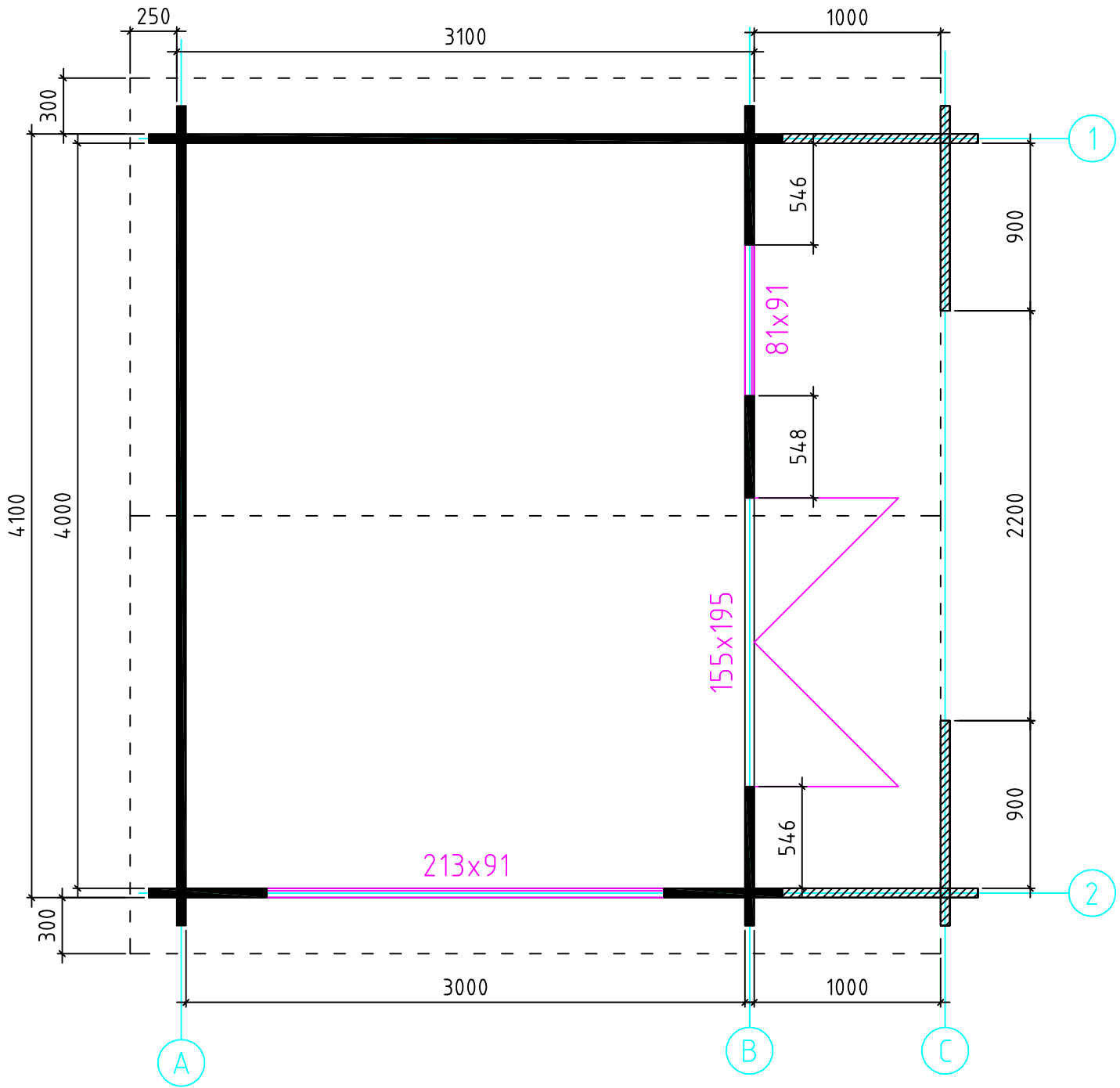

4x3+1,0 VD/T

4140

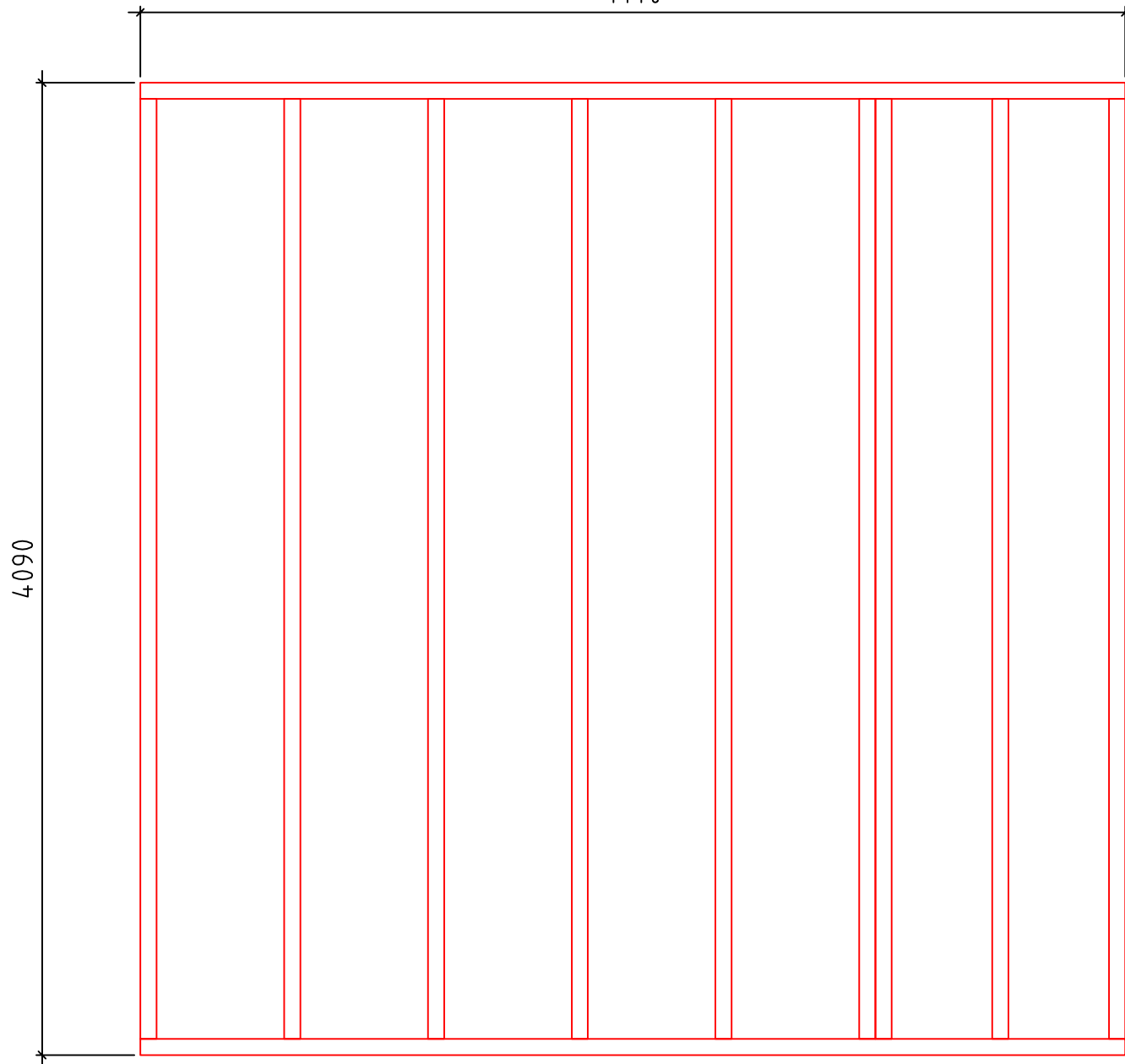

4090

Fundament

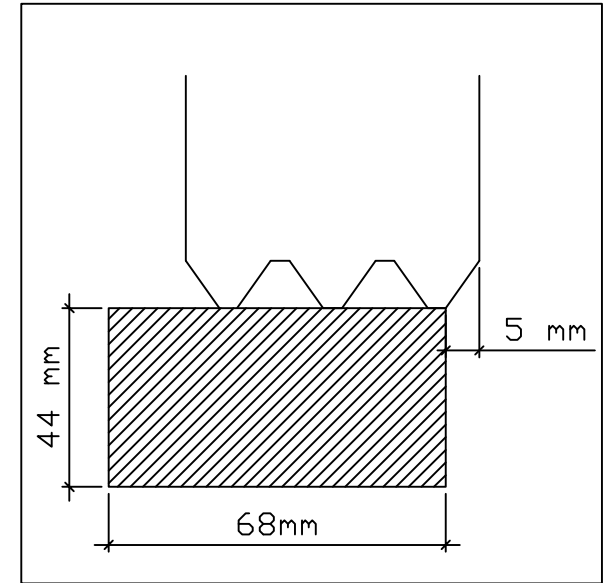

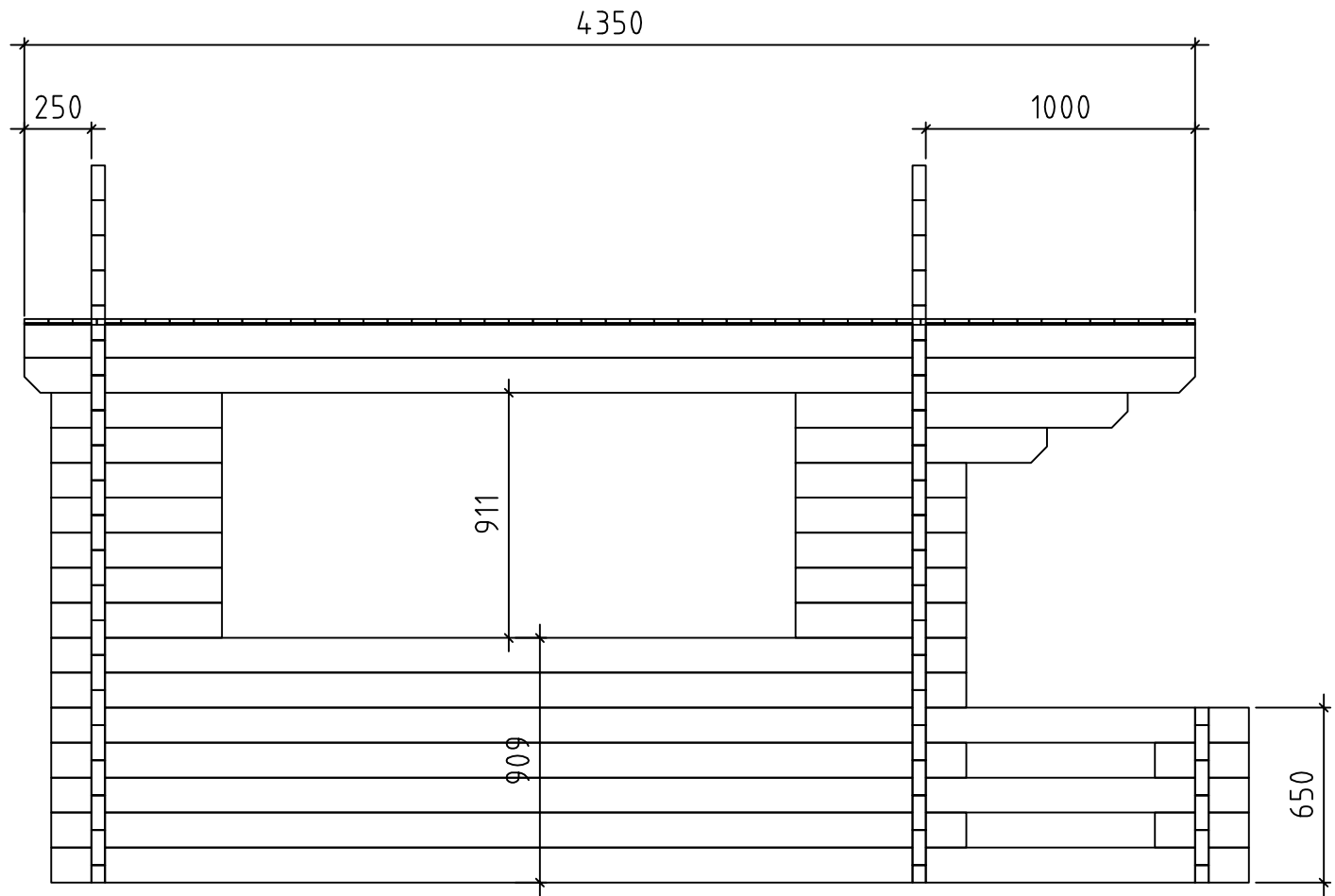

Wand 2 ↑

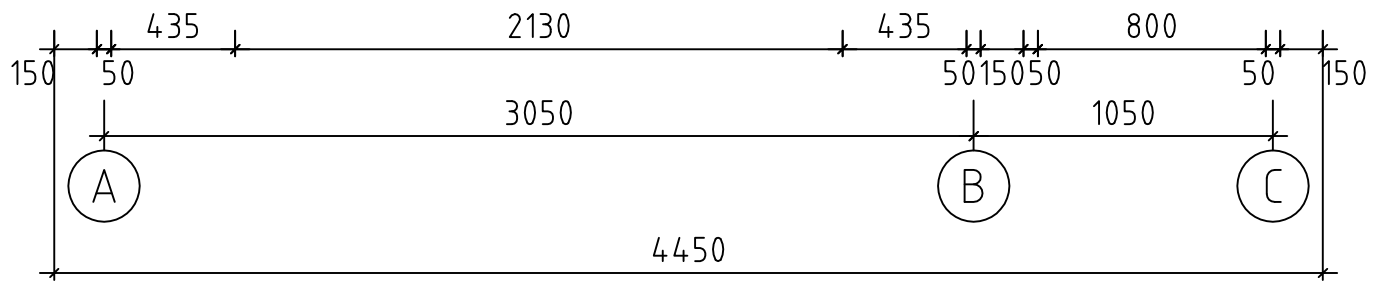

4x3+1,0 VD/T

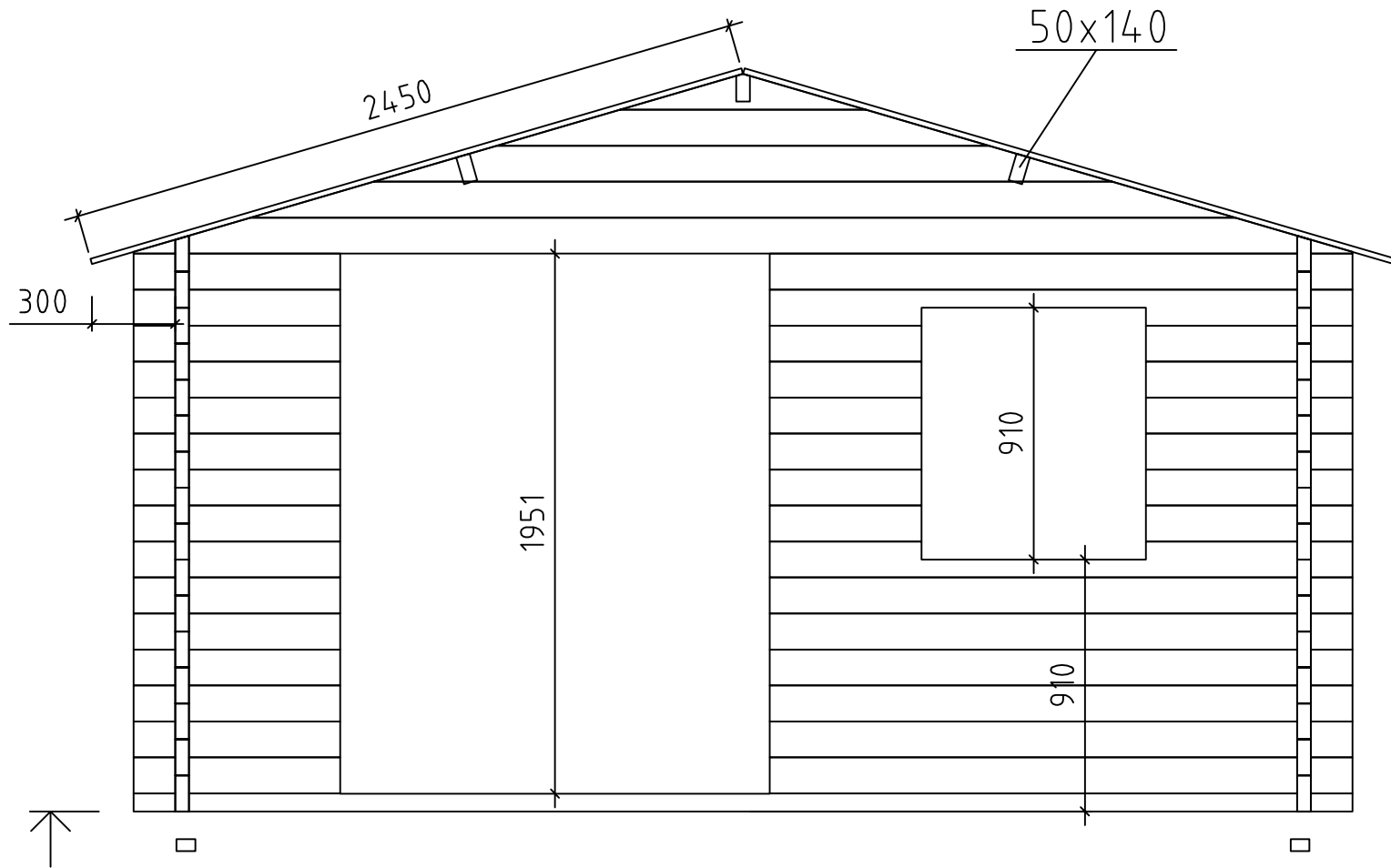

Wand B

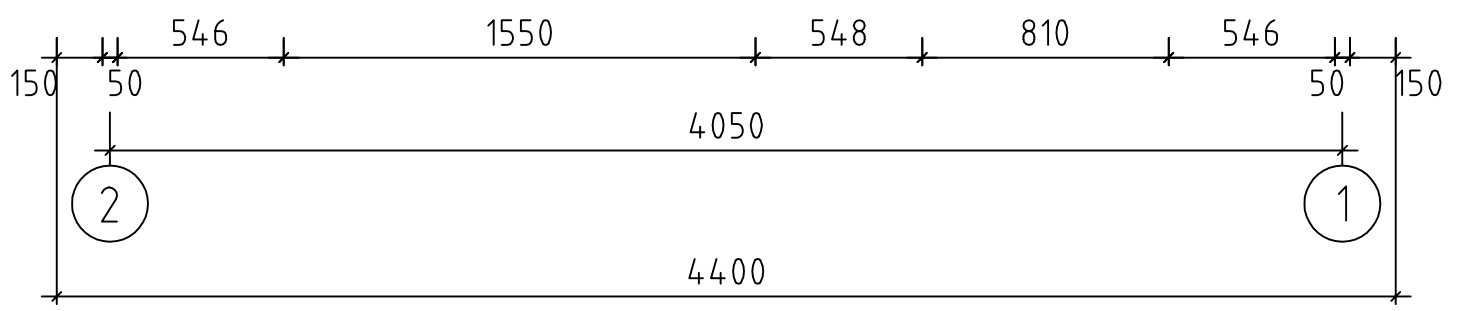

4x3+1,0 VD/T